

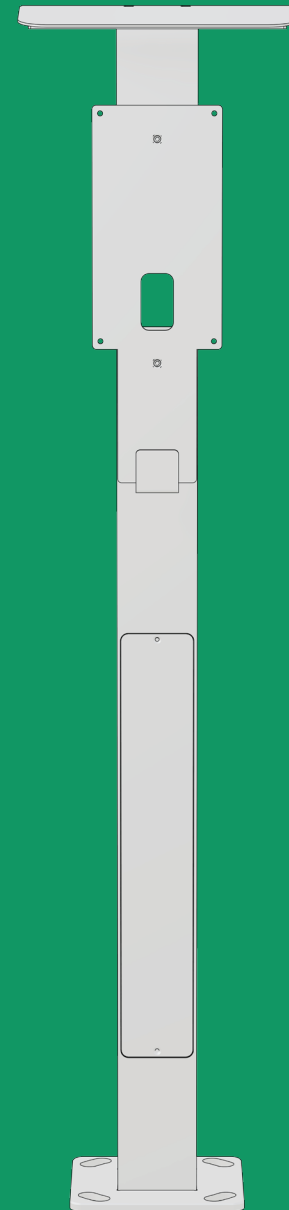

ONE SYSTEM ENDLESS POSSIBILITIES

Installation manual | 2021 | www.onepole.no



CONTENT

INTRODUCTION	2,3,
--------------	------

PRODUCTS	4,5,
----------	------

CHARGER	6,7,
---------	------

DESIGN	8,9,
--------	------

MODULAR

We are delivering wide variety of combinations to suite any type of applications.

SCALABLE

Besides its easiness of installation, ONEPOLE system can easily be upgraded from 1 charging unit to many within minutes. This unique capability will make sure your project is future proof and expandable.

UNIVERSAL

Choose your desired charger for our universal system. If you cannot find your charger, you are welcome to contact us and we will make it fit.

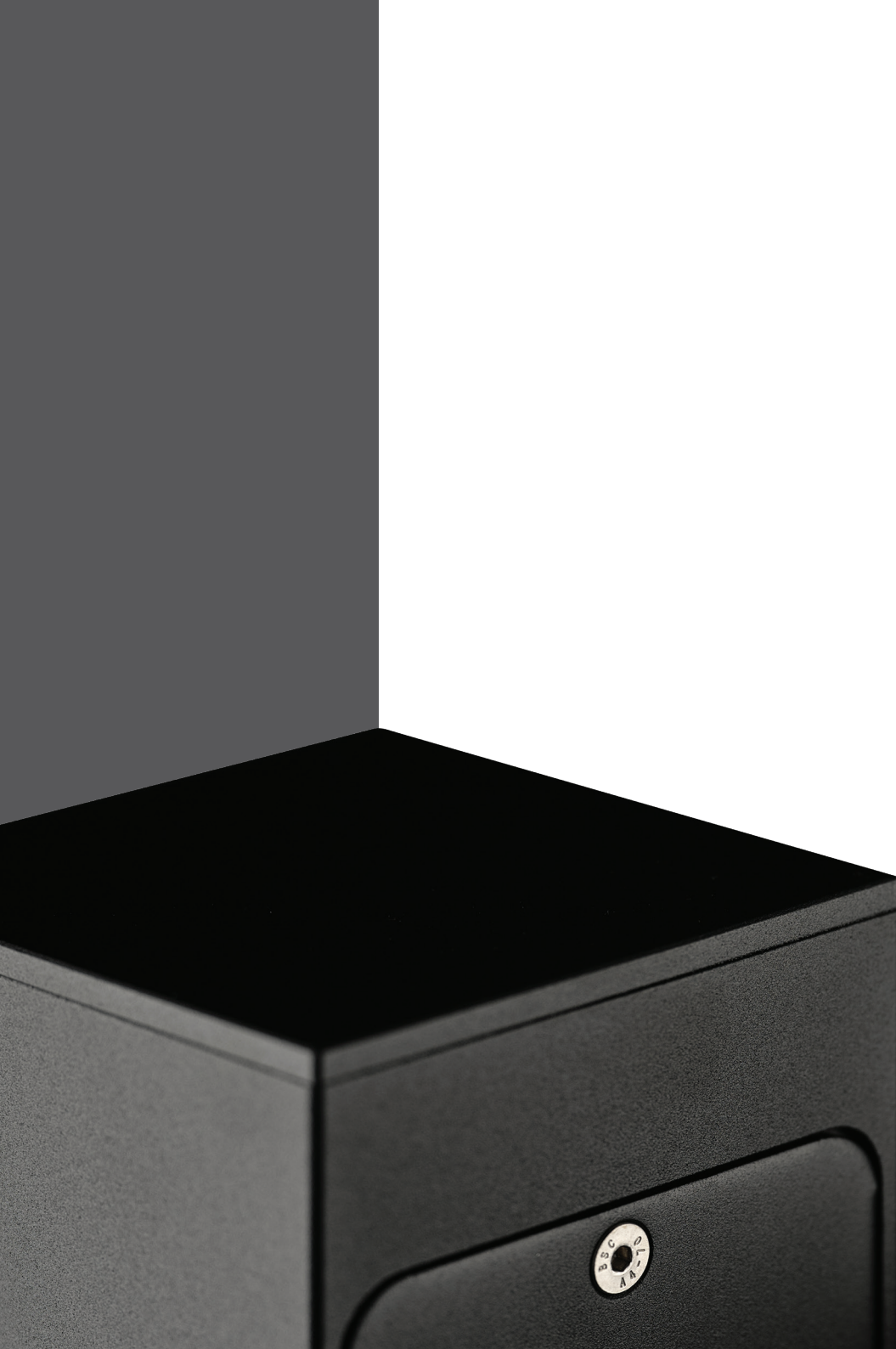

RIGID

ONEPOLE is made from seawater resistant aluminum. Ready for any environment.
ISO C4-M

PREMIUM QUALITY

Produced in Norway with carefully chosen high quality materials from **Hydro** together with JOTUN powder coating to ensure quality in every climate.
*standard color: RAL 9005
other colors on request*



PRODUCTS

Design your own charging pedestal with up to four chargers with only a single ONEPOLE. Unique and upgradable solution with wide variety of products, accessories and addons will make sure Onepole meets any required application

CONFIGURATOR

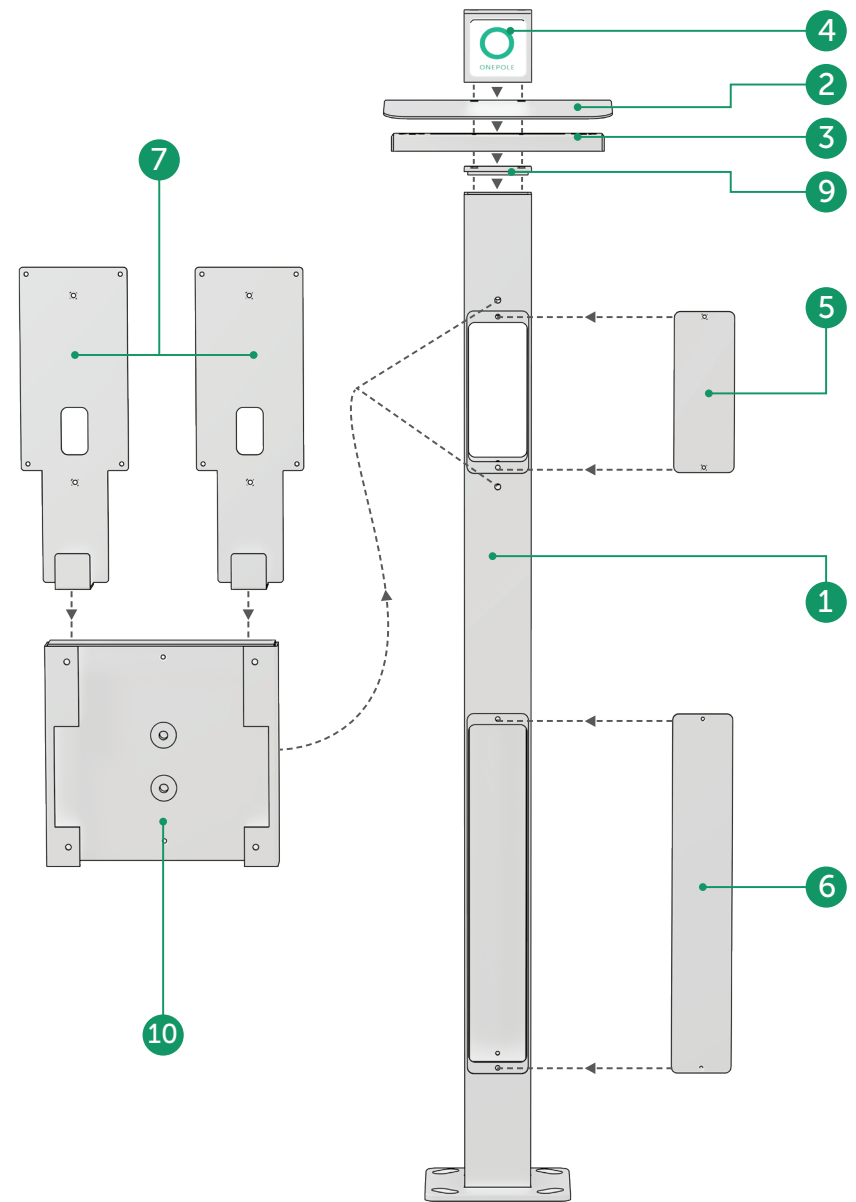

4

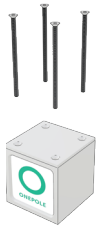

Numero Mini

2



Roof

3

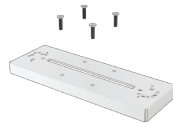

Lighting Bracket Duo

3



Lighting Bracket Uno

9

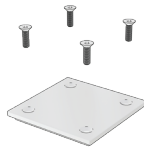

Top Lid

6



Connection Lid

7



Bracket

5



Blind Cover



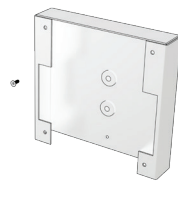

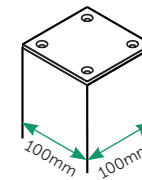
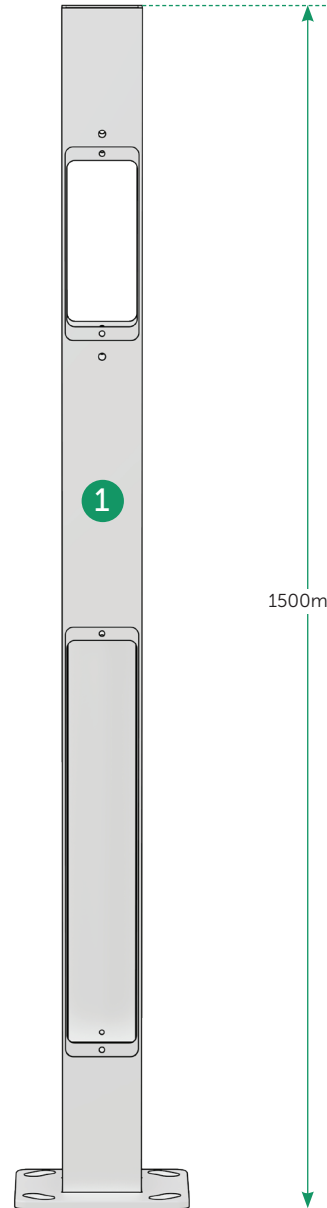

10



Side by Side



1500mm

- 10 7 2x (M6 x 16) 
- 3 4x (Ø 10mm) 
- 9 3 2 4x (M6 x 20) 
- 6 2x (M5 x 10) 
- 5 2x (M5 x 10) 
- 4 4x (M6 x 140) 

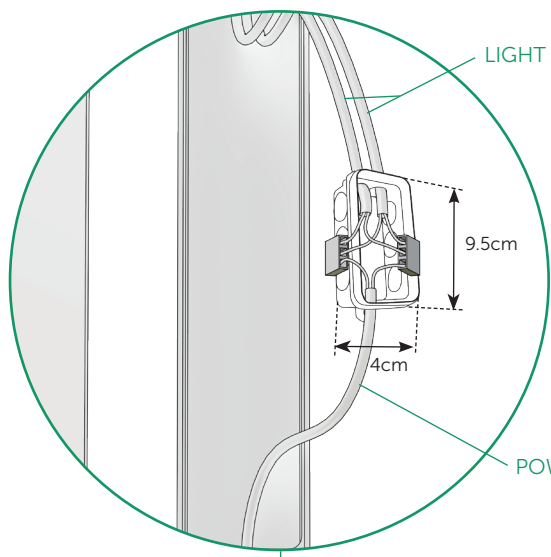
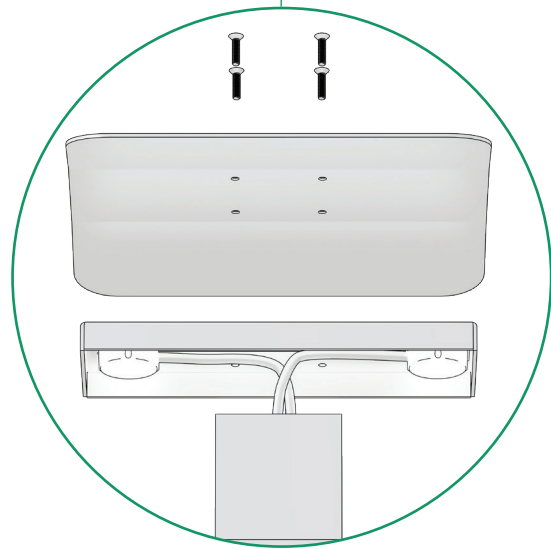
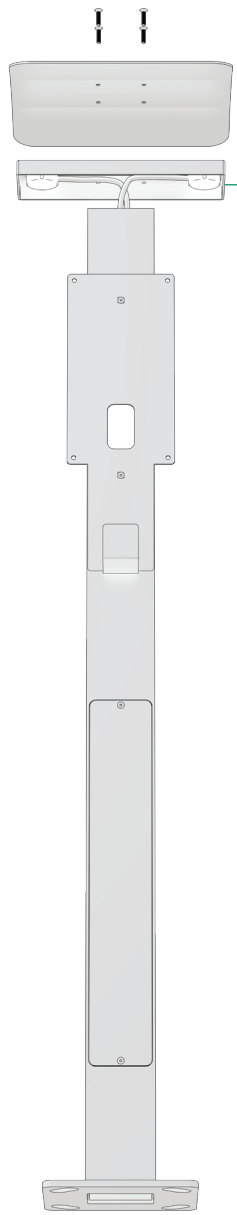

LIGHT UNIT CABLES

9.5cm

4cm

POWER SUPPLY

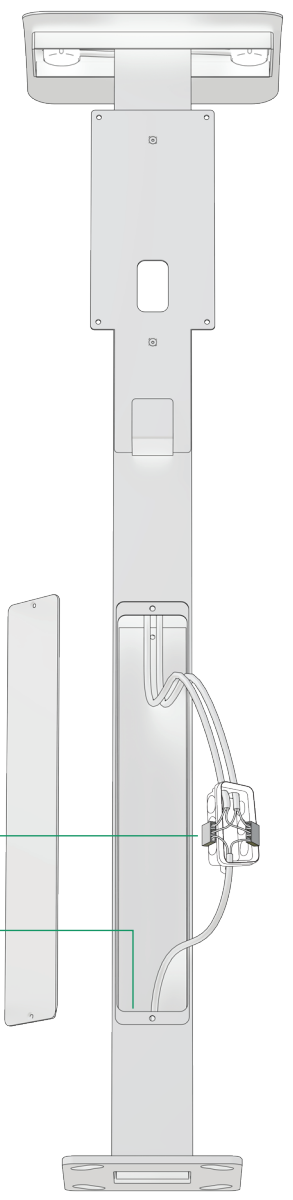

GROUNDING
2 + 1

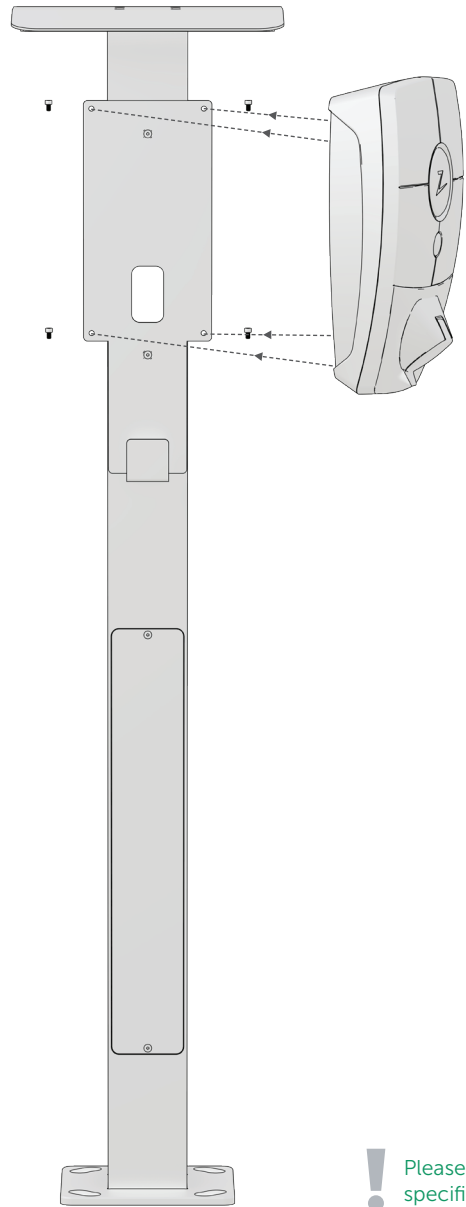

! Please read installation manuals for specific charging unit.

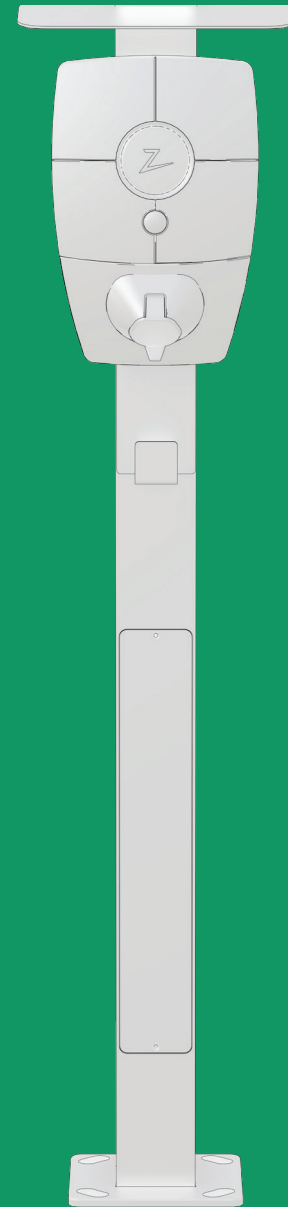



PRODUCED AND DESIGNED
IN NORWAY

